

Sun | Guard

Your Sunshade Experts

+64 27 217 9560

WWW.SUNGUARD.NZ

SALES@SUNGUARD.NZ

G/11 PIERMARK DRIVE,
ROSEDALE, AUCKLAND 0632



Here at SunGuard, we are passionate about bringing safe, fashionable, quality exterior and interior sunshade products into family homes and businesses. Our products will stand the test of time and add value to your property, while providing practical functionality and aesthetics.



Outdoor

- 01 Pergolas
- 02 Drop Down Screens: Ziptrak & Omni
- 03 Awnings: Retractable & Fixed
- 04 Outdoor Automation
- 05 Shade Sails
- 06 Retractable Wave Shades
- 07 Aluminium Shutters



Interior

- 08 Plantation Shutters: PVC & Timber
- 09 Venetian Blinds: Timber, PVC & Aluminium
- 10 Roller Blinds
- 11 Honeycomb Blinds
- 12 Pleated Blinds
- 13 Vertical Blinds



Transparent Roofing Systems



SunGuard ClearVue® Aluminium Pergola is a premium canopy solution that allows to expand your outdoor living area and shelter it from UV rays, heat, and the elements.

Our custom made aluminium pergola system is crafted with precision using high quality components, ensuring durability in any weather. Each pergola is tailored to your requirements and can be powder coated to any Dulux colour. Our pergolas can be wall-mounted, installed using custom soffit brackets, or designed as a standalone structure.

We cover our pergolas with flat, lightweight, robust polycarbonate and acrylic panels that block up to 99% of UV rays and are easy to clean. These high-quality panels can be installed onto new and existing structures using our self-supporting span bar system. Complete your pergola with SunGuard outdoor blinds like Ziptrak and Omni, or Muriwai aluminium shutters.

CLEARVUE® ACRYLIC AND POLYCARBONATE PANELS

- NZ's only BRANZ appraised translucent roofing system- lightweight and flexible, offers effective weather protection
- impact resistant - acrylic panels: 17 times stronger than glass, polycarbonate: 200 times stronger than glass
- excellent light transmission - up to 89% (better clarity than glass)
- light weight - around half the weight of glass
- longevity - UV resistant in nature, unsusceptible to yellowing or discoloration from the sun, durable against scratches, resistant to corrosive atmospheres
- thermal efficiency - effective insulation, blocks up to 45% heat
- **15-year full replacement warranty (panels)** *Ts & Cs apply

UNIVERSAL GLAZING SYSTEMS (UGS) POLYCARBONATE PANELS

- high impact strength - 200 times stronger than glass, durable against chips and cracks
- good light transmission - up to 87%
- light weight - around half the weight of glass
- longevity - superior longevity & resistance to the effects of weather is achieved by co-extruding a 50-micron UV protective layer onto both sides of each sheet.
- thermal stability - minimal property change within the range of -20 to 120 degrees Celsius
- thermal efficiency - good thermal insulation
- **10-year full replacement warranty (panels)** *Ts & Cs apply



Blue Breeze Panels



Clear Panels



Grey Tint Panels

01 PERGOLAS

Outback® Flat Roof

Create a stylish outdoor living space that complements your home with the sleek, minimalistic design of the Outback® Flat Roof.

This adaptable roofing system can be customized to cover any area around your house, available as standalone units, gable roofs, or pergola systems. Whether freestanding or attached, it serves perfectly as a veranda or carport.

Featuring optional translucent panels for filtered natural light and beams with span up to 8.4 meters in 120mm or 150mm sizes.

Available in a range of high gloss colours to match your home, this pergola boasts a steel roofing sheet with a smooth underside for a polished 'ceiling-like' finish. With spans up to 4.5 meters, support beams can be spaced further apart for a clean, uncluttered aesthetics. Chamfered and fluted beams and posts add both strength and elegance.

KEY FEATURES

Fully customized (style, shape, size & colour)

Innovative market-leading design

Engineer tested and certified

Attractive high-gloss finish

Large spans provide a clear, uncluttered appearance

Enclosed framework, hidden fixings, and contoured brackets ensure a clean, tidy appearance

WARRANTY (Ts & Cs apply)

Structure – 25 years

Powder coating – 8 years

Workmanship – 3 years



Kudos Louvre Pergola



Discover the Kudos Louvre Pergola – an all-weather solution designed to provide shade and ventilation control all year-round. Whether shielding from intense summer sun or rain, this versatile pergola ensures comfort in any weather condition.

KEY FEATURES

180-Degree Blade Rotation: Control sunlight and shade with full blade rotation, adapting to your outdoor space effortlessly.

Stylish and Durable: Combines sophistication with robust durability for a timeless aesthetics.

Long Louvre Spans: Achieve expansive coverage and openness, enhancing design and functionality.

Waterproof Design: Equipped with integrated guttering for efficient water drainage.

Motorised or Manual Operation: Choose the convenience of automation or ease of manual operation.

Powder coated and Anodised Finishes: Offers aesthetic appeal and additional protection to the components.

Various Colour Options: Personalise with a range of colours to seamlessly blend with your outdoor space.

Customisable: Tailored to any size and shape, creating a bespoke outdoor haven.

Free-Standing or Attached: can be built as a standalone feature or attached to the existing structures.

Integrated LED Lighting: Enhance ambiance with adjustable LED lighting for every occasion.

WARRANTY (Ts & Cs apply)

Structure – 10 years

Powder coating – 10 years

Workmanship – 3 years

Automation – 5 years

Omega Retractable Pergola

Somfy Automated



Transform your outdoor living areas with **the Omega Pergola**, a retractable roof system designed to expand and enhance your space.

Engineered to withstand New Zealand's challenging weather, the Omega Pergola is proudly manufactured locally, ensuring consistent quality and great turnaround time. This robust system boasts impressive wind resistance, capable of enduring winds up to scale 10 Beaufort (48-55 knots).

KEY FEATURES

Expansive Coverage: Up to 15m wide and 10m projection with 4 modules

Customisation: Tailored hardware colours and configurations, with or without supporting posts

Optional Features: Integrated LED lighting, Wind/Rain/Sun sensors, compatibility with outdoor blinds

ADDITIONAL DETAILS

Recommended Pitch: 9 degrees

Operation: Somfy motorisation

Frame Colour: Custom powder coating (Dulux range)

FABRIC

Serge Ferrari waterproof fabrics - lightweight, durable, and 100% recyclable, ensuring longevity and sustainability.

- Soltis Proof W96: Textured, neutral shades with high dimensional stability.
- Soltis Proof 502: Heavy-duty, satin finish membrane for superior weather protection.

WARRANTY (Ts & Cs apply)

Fabric - 10 years

Components - 5 years

Workmanship - 5 years

Automation (Somfy) - 5 years

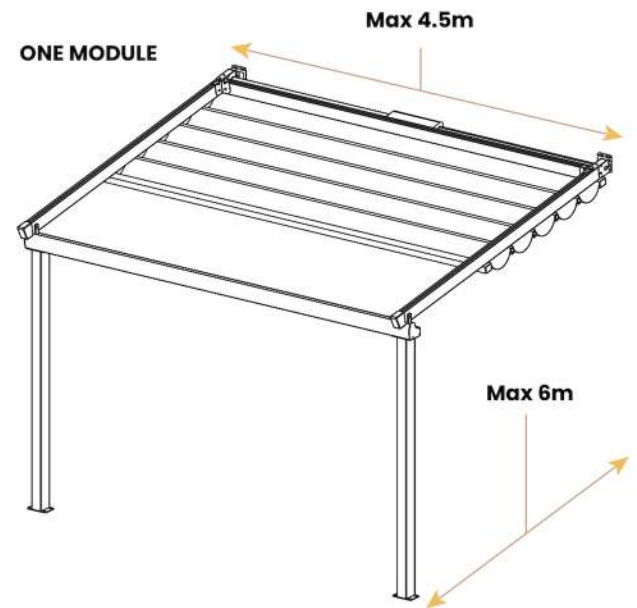

02 OUTDOOR BLINDS

Ziptrak®

Premium track-guided drop down screen

Transform your outdoor space with the premium Ziptrak® exterior screen system, proudly made in NZ. Designed to provide superior protection from sun, dust, wind, and rain, this outdoor blind ensures year-round comfort for your entertaining areas.

The Ziptrak® system features a spring-loaded mechanism for effortless manual operation, allowing the screens to glide smoothly and stop at any desired position. For added convenience, automation packages with wind and sun sensors are available for mesh fabric screens.

Every Ziptrak® screen is custom-made to fit your specifications and can be installed either between posts and walls or onto surfaces using face-fix channels. With a sleek, cord-free design, there are no wires or floor locks, ensuring an unobstructed view and enhanced safety.

WARRANTY (Ts & Cs apply)

Components - 3 years
 Somfy motors - 5 years
 Alpha motors - 7 years
 Screen Fabrication - 3 years

Workmanship - 5 years
 Mesh - 10 years
 Achilles PVC - 3 years

COMPONENT COLOURS

Pearl White
 Satin Black
 Ironsand
 custom powder coating
 (Dulux range)

FABRIC

Shadeview Mesh - 36 colours
 Serge Ferrari Soltis Mesh - 45 colours
 Serge Ferrari Soltis W96 - 5 colours
 Clear or tinted Achilles PVC (0.75 mm)
 (Fire Retardant PVC available)
 Docril Acrylic Canvas - 79 colours



WIDTH x HEIGHT

MIN - 650 x 500 mm
 MAX PVC - 5500 x 3500 mm
 MAX Mesh - 6000 x 3500 mm

OPERATION

Manual
 Automated with Somfy
 or Alpha (mesh only)

PELMET / FRONT VIEW (mm)

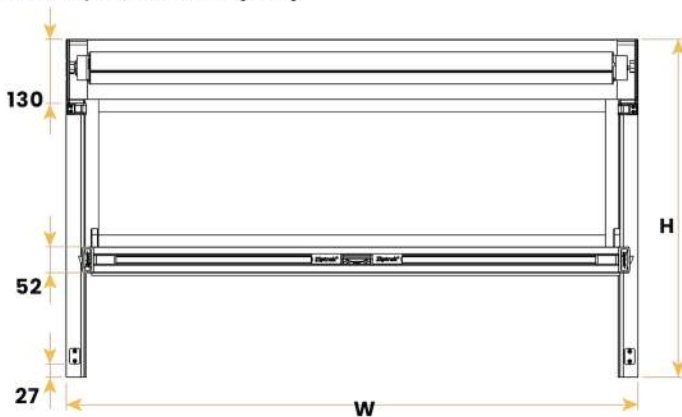

PROTECTION

135 mm small pelmet - drops up to 2800 mm
 165 mm large pelmet - drops up to 3500 mm
 135 mm flashing (covers only one side) of the tube
 Custom made flashings/infills

PELMET / SIDE VIEW (mm)

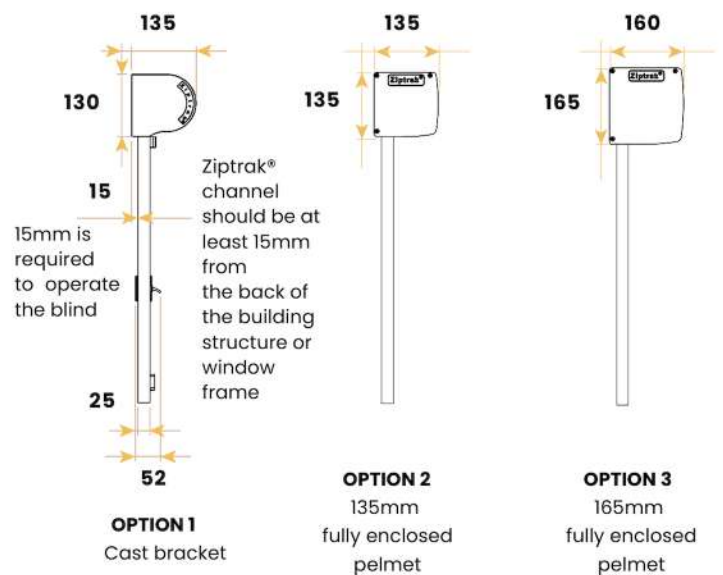

Omni (Café) Blind

Crank handle operated drop down screen

Designed and manufactured in NZ, Omni screens, also known as Café blinds, combine practicality with style. Tailored to suit commercial and residential project needs, Omni come in three different modifications – **Lite**, **Guide** and **Channel**.

Omni Lite is a minimalistic straight drop screen with floor level stainless steel anchors. Can be crank handle operated or automated, rolls neatly away when not in use.

Omni Guide is fitted with stainless steel guide wires installed at the sides of the screen. The wire guides allow safe operation when rolling away and minimise flapping in the wind when the blind is halfway open.

Omni Channel is the most popular system with aluminium side channels that increase protection and provide a streamlined finish. Blind locks are integrated into the bottom bar, leaving the floor free of hooks or latches.

WIDTH x HEIGHT

MIN – 500 x 500 mm

MAX – 4500 x 3000 mm

OPERATION

Crank handle

Automated (Somfy/Alpha)

COMPONENT COLOURS

Pearl White

Silver Pearl

Satin Black

custom powder coating (Dulux range)

WARRANTY (Ts & Cs apply)

Components – 3 years

Somfy motors – 5 years

Alpha motors – 7 years

Workmanship – 5 years

Mesh – 10 years

Achilles PVC – 3 years

FABRIC

Shadeview Mesh – 36 colours

Serge Ferrari Soltis Mesh – 45 colours

Serge Ferrari Soltis W96 – 5 colours

Clear or tinted Achilles PVC (0.75 mm)

FR PVC available

Docril Acrylic Canvas

OPTIONS

Wire guides

Side channels

135 mm flashing

135 mm pelmet

Prints on mesh and PVC



OMNI LITE

OMNI GUIDE

OMNI CHANNEL



02 OUTDOOR BLINDS

Achilles PVC

Discover Achilles PVC, the ultimate solution for enjoying the outdoors in any weather conditions. Manufactured in Japan, this market leading UV-stabilised PVC is renowned for its exceptional clarity and durability, making it perfect for both crank handle operated Omni (Café) blinds and Ziptrak® screens in both residential and commercial settings.

FEATURES

- UV stabilised for longevity
- Non-stick formulation (SLS) for easy maintenance
- High clarity, ensuring clear views
- Fire Retardant (FR) option available
- Ideal for commercial, hospitality, residential blinds, and marine clears.

TECHNICAL SPECIFICATIONS

- Material: Clear PVC
- Width: 137 cm
- Roll Length: 30 meters
- Thickness: 0.75mm
- Fire Retardant PVC available
- Finish: Clear and Tinted



Mesh & Opaque Fabrics

At SunGuard, we use premium quality fabrics from two esteemed brands: **Serge Ferrari** (France) and **Shadeview** (Australia).

ShadeVview provides a classic aesthetic with its basket weave fabrics. Skillfully engineered, Shadeview fabrics diffuse light, optimize views, and block up to 99% of the sun's rays, ensuring both comfort and style in any outdoor environment.

Serge Ferrari Soltis series offers practical durability with exceptional heat and UV protection. These soft, perforated fabrics create cosy, shaded outdoor areas with glare-free visibility. Their modern patterns and extensive colour palette effortlessly enhance any setting and are easy to maintain.

We can also offer **Docril acrylic canvas**, known for its 100% solution-dyed acrylic material from Spain. Docril boasts exceptional dimensional stability, high water repellence, and strong resistance to abrasion, rot, and mildew. With fantastic colour fastness rating, Docril offers 79 premium fabrics in plain and striped designs, providing excellent sun protection by blocking up to 90% of harmful UV rays.







Fabric		Overview	Weave Openness (mesh only)	Privacy	View	Shade	Wind/Rain Protection	Warranty
PVC ACHILLES	Clear	<ul style="list-style-type: none"> UV-stabilized High clarity FR options available Designed in Japan 	N/A	No privacy	Excellent	No shade	Excellent	3 years
	Tinted			No privacy	Excellent	Minimal	Excellent	
MESH SHADEVIEW	Classic	<ul style="list-style-type: none"> Classic look of basket weave Mildew and fade resistant Best for track guided blinds Designed in Australia 	10%	Good	Very Good	Good	Minimal	10 years
	Urban		5%	Very Good	Good	Very Good	Fair	
	Extreme		3%	Very Good	Fair	Very Good	Fair	
	NEW! One		1%	Excellent	Fair	Excellent	Good	
MESH SERGE FERRARI SOLTIS	Soltis Horizon 86	<ul style="list-style-type: none"> Soft breathable micro-perforated fabric Excellent heat and UV protection Mold, dirt, and fade resistant Designed in France 	14%	Fair	Very Good	Fair	Minimal	
	Soltis Harmony 88		8%	Good	Good	Good	Fair	
	Soltis Lounge 96		4%	Very Good	Fair	Very Good	Fair	
	Soltis Proof W96		0%	Excellent	No View	Excellent	Excellent	

Fetuna Cassette

The **Fetuna Cassette** showcases elegant French design and superior components, meticulously crafted to measure in Auckland. Its enclosed cassette protects the fabric and mechanism when retracted, ensuring longevity and minimal maintenance. Made with premium powder coated, rust-resistant aluminium and marine-grade stainless steel hardware, the Fetuna Cassette is built to last while adding a touch of sophistication to any space.



	MINIMUM & MAXIMUM SIZE (WIDTH X EXTENSION)	HARDWARE COLOURS	FABRIC	OPERATION	INSTALLATION	OPTIONAL
						AUTOMATION
Fetuna (cassette awning) 	Min 2487x2000mm Max 6000x4000mm or 7000x3500mm	Warm White Pearl Silver Pearl Matt Charcoal  Optional custom powder coating Dulux range	Docril Acrylic Canvas 79 colours (plains & stripes)	Manually operated (crank handle) or Automated (remote control or wall switch)	Face fix (wall mounted) Soffit undermount L-Brackets Custom made brackets	Alpha (Aus-US) or Somfy (France) motorisation Wind (motion) sensor Sun & rain sensors Wi-Fi hub
Integral (full cassette awning) 	Min 1815x1500mm Max 5000x3000mm	Warm White Pearl  Optional custom powder coating Dulux range				

WARRANTY: Components - 5 years Workmanship - 5 years Docril Acrylic Canvas - 10 years Alpha Motors - 7 years Somfy Motors - 5 years

Integral Cassette

The **Integral Cassette** boasts sleek French design, high-quality components, and is made to measure in New Zealand. This full cassette awning fits seamlessly into any architectural style, requiring just 180 mm of wall space. It is supplied with a support beam (timber or aluminium) installed onto the wall/soffit, as it only has two brackets (one per side). The full cassette design means the fabric and arms are fully protected from the back as well, encapsulated for a clean look and effective protection when retracted.







03 AWNINGS

Ellipse

The Ellipse is our go-to awning, known for its simplicity and charm with locally sourced components for budget-friendly pricing. It can be fitted with an optional half pelmet made of powder coated rust-resistant aluminium, which covers the top of the awning and is highly recommended for automated units to provide extra protection to the motor and canvas. Additionally, the Ellipse features an adjustable pitch option that is manually operated with a crank handle, allowing you to effortlessly adjust the angle of the awning as needed.



	MINIMUM & MAXIMUM SIZE (WIDTH X EXTENSION)	HARDWARE COLOURS	FABRIC	OPERATION	INSTALLATION	OPTIONAL		
						PROTECTIVE HOOD	ADJUSTABLE PITCH	AUTOMATION
Ellipse (open type awning) 	Min 2020x1500mm (manually operated) Min 1970x1500mm (automated) Max 6000x4000mm	Warm White Pearl Silver Pearl Matt Black  Optional custom powder coating Dulux range	Docril Acrylic Canvas 79 colours (plains & stripes)	Manually operated (crank handle) or Automated (remote control or wall switch)	Face fix (wall mounted) Soffit undermount L-Brackets Custom made brackets	Yes (covers the top of the awning)	Yes (allows to manually adjust the pitch of each arm)	Alpha (Aus-US) or Somfy (France) motorisation
Horizon (open type awning) 	Min 1948x1500mm (manually operated) Min 1888x1500mm (automated) Max 6000x4000mm	Warm White Pearl Silver Pearl Matt Charcoal  Optional custom powder coating Dulux range						
WARRANTY: Components - 5 years Workmanship - 5 years Docril Acrylic Canvas - 10 years Alpha Motors - 7 years Somfy Motors - 5 years								



Horizon

The Horizon is our premium heavy-duty open-type awning, designed in France and expertly made in NZ, trusted here for over 15 years. Built with reinforced mounting brackets, this awning ensures superior durability and stability. Standard hardware colours include warm white, silver pearl, and matt charcoal. For enhanced durability, especially for automated units, the Horizon can be fitted with an optional half pelmet that covers the top of the awning, safeguarding the motor and extending the lifespan of the canvas.



Vertigo Window Awning

The **Vertigo drop arm awning** stands out as one of the sturdiest and most wind-resistant shade options available, thanks to its four-point fixing system. Engineered in France and crafted in NZ, it combines robustness with refined design for exceptional durability and performance. Available with 1m and 1.5m long arms and in widths up to 4.5m, it seamlessly complements sliding doors and windows, blending elegance with practicality.



	MINIMUM & MAXIMUM SIZE (WIDTH X ARMS LENGTH)	HARDWARE COLOURS	FABRIC	OPERATION	INSTALLATION	OPTIONAL	
						PROTECTIVE HOOD	AUTOMATION
Vertigo (drop arm window awning) 	Min 500x1000mm Max 4500x1500mm	Warm White Pearl Silver Pearl  Optional custom powder coating Dulux range	Docril Acrylic Canvas 79 colours (plains & stripes)	Manually operated (crank handle) or Automated (remote control or wall switch)	Face fix (wall mounted) Soffit undermount	Yes (covers the top of the awning)	Alpha (Aus-US) or Somfy (France) motorisation Wind (motion) sensor Sun & rain sensors Wi-Fi hub
WARRANTY: Components - 5 years Workmanship - 5 years Docril Acrylic Canvas - 10 years Alpha Motors - 7 years Somfy Motors - 5 years							

Waterproof Fixed Frame Awning



Custom-made in New Zealand, our **fixed frame awnings** are engineered to endure all weather conditions. The welded, high-quality extruded aluminium frame is securely attached to the building without the need for additional posts and can be customized with any Dulux colour in a powder coated finish. We offer a range of frame shapes to suit various aesthetic preferences, including classic wedge, Spanish hoop, and vertical hoop. For businesses, our fixed frame awnings can feature a flat front message panel for signage printing. Enjoy peace of mind with our 5-year warranty covering framing and workmanship.

FABRIC

Choose from 34 colours in the Austrian-made Diamond 700 Series for effective defence against sun, wind, and rain, backed by a 5-year warranty. Opt for the Diamond Translucent PVC in white or grey for warm shade, enhanced by a weldable PVDF coating and a generous 7-year warranty.

03 AWNINGS

Awning Fabric

DOCRIL ACRYLIC CANVAS

Designed and manufactured in Spain, Docril stands out as the premier brand of 100% solution-dyed acrylic canvas for awnings, marine covers, and sun umbrellas. Renowned for its exceptional dimensional stability, Docril boasts high water repellence (Scotchguard Spray Test score of 100), and strong resistance to abrasion, rot, and mildew. With a remarkable color fastness rating of 7-8 on the Blue Scale, Docril fabrics are also treated to repel dirt and oil-based stains, ensuring easy cleaning with a dry cloth or light brushing. Featuring a wide selection of 79 premium quality fabrics in plain and striped designs, Docril offers options to complement any decor while providing outstanding sun protection. These fabrics block up to 90% of harmful UV rays, ensuring both visual and thermal comfort in any outdoor setting.

SERGE FERRARI SOLTIS FABRIC

Designed and manufactured in France, the Serge Ferrari Soltis series combines practicality with durability, offering outstanding heat and UV protection.

Soltis Lounge 96 (4% openness) features a soft, breathable micro-perforated fabric, perfect for creating shaded and cozy outdoor areas with glare-free visibility. The smooth surface resists dirt and mold, facilitating easy cleaning. Its unique pattern and plain color scheme add a touch of modern style to any home or business.

Colour fastness test ISO 105-B04

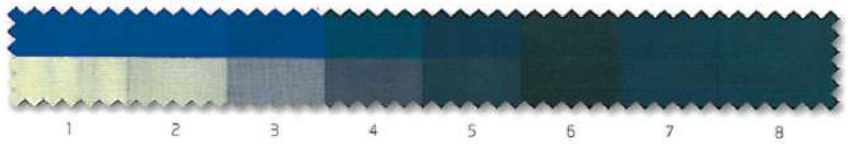

Awning Installation





As one of the world's leading manufacturers of shade motorisation solutions, **somfy** brings over 50 years of innovation and European style to outdoor automation. Their products are renowned for premium quality and are backed by a 5-year warranty.

MOTORS

Somfy offers RTS (integrated radio control) or WT technology (control via wires) tubular motors with up, down, and stop functions. They can be pre-programmed with "my" favourite position and integrated into Smart Home systems.

WEATHER SENSORS

Somfy provides the most reliable radio-controlled sensors for awnings, screens and blinds, which intelligently adjust behavior based on weather conditions. Sun, rain, and wind sensors are famous for intuitive programming.

CONTROL UNITS

Featuring a unique design, Somfy offers wireless wall-mounted RTS remotes from the Smoove Range. The "my" button allows easy access to preferred shade positions. Single and multi-channel handheld remote controls are available.

CONNEXOON WIFI HUB

An intuitive app control solution compatible with the entire range of Somfy RTS products. Connects up to 4 smartphones and offers voice control via Amazon Alexa and Google Assistant.



Alpha provides reliable motorization solutions known for their intuitive design and competitive pricing. They offer one of the best warranty policies on the market with 7 years of coverage.

MOTORS

High-quality motors designed for outdoor products, featuring a manual override optional function for open-type awnings. Both WT and RTS versions are available.

WEATHER SENSORS

Alpha sensors are compatible with retractable awnings, exterior screens, and indoor shade products. Paired motorized products retract automatically upon detecting high wind levels. Wireless sun and rain sensors are also offered.

CONTROL UNITS

Choose from wall-mounted switches or the Pioneer/Navigator series handheld remote controls. Options include 1/4/8/16 channel units.

NEO WIFI HUB & APP

Control motorized products individually, by area, or the entire house remotely via the internet. Includes scheduling features for automated operation.

05 SHADE SAILS



SunGuard's custom made shade sails are designed and manufactured in New Zealand. This local approach ensures stringent quality control while supporting local industries, providing shade solutions perfectly tailored to our unique climate.

From small residential projects covering decks and backyards to complex commercial installations for restaurants, cafes, businesses, warehouses, schools, playgrounds, kindergartens, and more, SunGuard caters to a diverse range of applications. We offer shade sails in two designs: **webbing edge** and **wire edge**.

WIRE EDGE

(recommended for exposed areas and sails over 30m perimeter)

Designed for versatility and durability, the wire edge shade sail boasts:

- **Various Wire Sizes:** Ranging from 4mm to 8mm, offering flexibility in design and installation
- **On-Site Adjustability:** Easily adjustable during installation for optimal positioning and tensioning
- **Robust Construction:** Crafted with a 7 x 19 strand wire cable, ensuring strength and stability in various weather conditions
- **Marine Grade Components:** Marine grade SS 316 stainless steel components for longevity and resistance to corrosion

WEBBING EDGE

(recommended for smaller residential projects)

Crafted with durability and resilience in mind, the webbing edge shade sail offers:

- **Super Strong Webbing:** UV-resistant polyester multi-strand webbing provides exceptional strength, boasting a 30kN Breaking Load, making it perfect for coastal conditions
- **PTFE Sewing Thread:** Seam strength is guaranteed throughout the fabric's lifespan, thanks to PTFE sewing thread that resists deterioration, bursting, or breaking even under extreme weather conditions
- **Stainless Steel Hardware:** Featuring marine grade SS 316 Stainless Steel hardware, ensuring high rust resistance and a polished finish, granting durability and longevity in coastal environments

Premium Shade Sail Fabrics

Quality matters for sun protection. We offer commercial-grade fabrics **Shadetec 320**®, **Extrablock 330**®, and **Monotec 370**®, providing up to 99% UVR block while allowing light and airflow. Developed in Australia, these HDPE monofilament and tape filament fabrics ensure robust strength, exceptional shade, and reduced heat and glare. Our fabrics are stain, dirt, and grime resistant, eco-friendly, and 100% recyclable.

For heavy-duty waterproof shade sails, we use **Serge Ferrari Soltis 502**. This PVC fabric features a satin finish, excellent colour fastness, and provides heat and weather protection while remaining lightweight, durable, dirt-resistant, and easy to maintain.

FABRIC	SHADE FACTOR (varies by colour)	UVR BLOCK (varies by colour)	COLOURS	FEATURES	IDEAL FOR	UV WARRANTY (Ts & Cs apply)
Shadetec 320	70.9% - 88.4%	91% - 95%	14	<ul style="list-style-type: none"> • Stain/grime & mildew resistant • Abrasion resistant yarn • Single colour filaments ensure consistent colour tone 	Smaller residential shade sails	13 years
Monotec 370	84.1% - 88.5%	84.1% - 88.5%	15	<ul style="list-style-type: none"> • Stain/grime & mildew resistant • Extra wide fabric ensures seams in sails are kept to a minimum 	Larger sails & structures, commercial projects	15 years
ExtraBlock 330	96% - 98%	96% - 98%	21 Note: Cream, Beige, Yellow & Red are not FR	<ul style="list-style-type: none"> • Rot/mold & mildew resistant • Fire retardancy rated FRAS1530.2/FRAS1530.3/Complies with CSFM 	Windy areas, car parks, commercial structures	10 years
Waterproof (PVC) - Serge Ferrari Soltis Proof 502	80% - 90%	82% - 99%	40	<ul style="list-style-type: none"> • Stain/grime & mildew resistant • Fire retardancy rated FRAS1530.2/FRAS1530.3/Complies with CSFM 	Shade & rain protection Note: waterproof fabric requires different heights at attachment points.	10 years



D-Shackle, Eye Bolt



Sail Track



Chain Adjuster

FIXING OPTIONS

Choose from a variety of reliable fixing options tailored to your needs, including twisted shackles, D-shackles, eye plates, eye bolts, and chain adjusters. Fixing options depend on factors such as fixing point locations and sail perimeter, ensuring secure installation and adjustable sizing for optimal coverage. Additionally, we offer a **sail track** feature, ideal for filling in the gaps. Track-edged sails from SunGuard are perfect for installations along walls or under eaves, providing increased shade coverage. When the track runs along a solid surface such as a wall or beam, it ensures enhanced stability and durability, making it an excellent choice for maximizing your shade.



PRECISION ENGINEERING

Utilizing CAD software, our shade sails are made with precision, incorporating best fittings for optimal installation. Marine-grade stainless-steel hardware ensures strength and durability, guaranteeing resilience in the toughest outdoor conditions. Whether mounted on steel posts, existing structures, or buildings, our shade sails are built to endure.

CATENARY CURVE

To ensure functionality and style, SunGuard shade sails feature a catenary curve (5% to 7% of the side) that distributes tension evenly. This curvature enhances stability and durability, though it may slightly reduce coverage. Our design software optimizes the catenary curve for each project, accommodating obstacles like trees or posts.

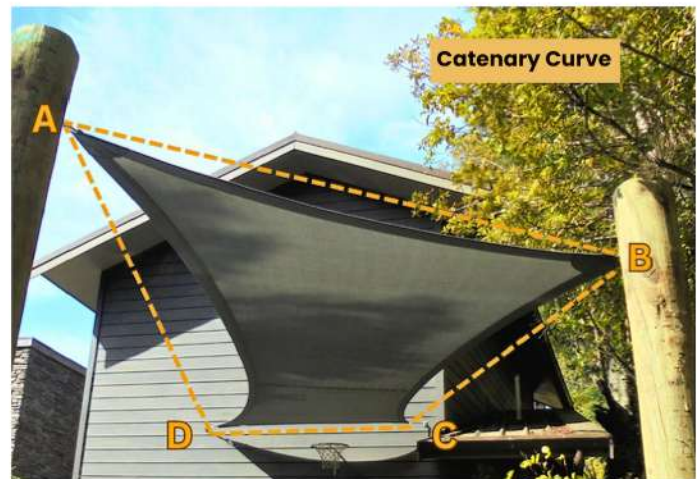

Catenary Curve

SUSPENDED MID-POINT (KISSING POINT)

Suspended mid-points offer a convenient solution when installing two shade sails side by side. By connecting to each other, they efficiently reduce the gap between sails, providing additional shade without the need for extra poles.

COMPREHENSIVE INSTALLATION SOLUTIONS

SunGuard services include not only premium shade sails supply but also comprehensive installation services tailored to your needs. We offer **galvanized steel posts in various sizes**—114 mm, 140 mm, and 168 mm OD—each available in lengths up to 6500 mm and concreted into the ground for optimal stability and longevity. Using **Hydro Excavation techniques**, we ensure precise post installation with minimal disruption to your outdoor space. Additionally, we offer **temporary fencing solutions** for school installations and commercial projects upon request. For a personalized touch, we can powder coat the posts to any Dulux colour, ensuring both functionality and aesthetic appeal.



Temporary Fencing



Mixed Colours



Kissing Point

06 RETRACTABLE WAVE SHADES

Wave Shade



Wave shades provide a stylish and practical alternative to traditional shade sails, and are ideal for residential or commercial outdoor areas. They are fully customizable and designed to withstand tough weather conditions. You can extend or retract the shades in seconds, and they come in various colours, suitable for timber and aluminium pergolas. Each wave shade system is tailored to your project's specifications, ensuring a perfect fit. They come with a 5-year warranty.

OPERATION

Wave shades offer user-friendly operation with two retraction options: an integrated cord system or a pole retraction system. The cord system uses a stainless-steel pulley and a braided polyester cord, functioning like a blind, with the ability to lock the shade halfway. The pole system involves an aluminium pole that hooks onto a stainless-steel cleat, manually retracting and extending the shade.

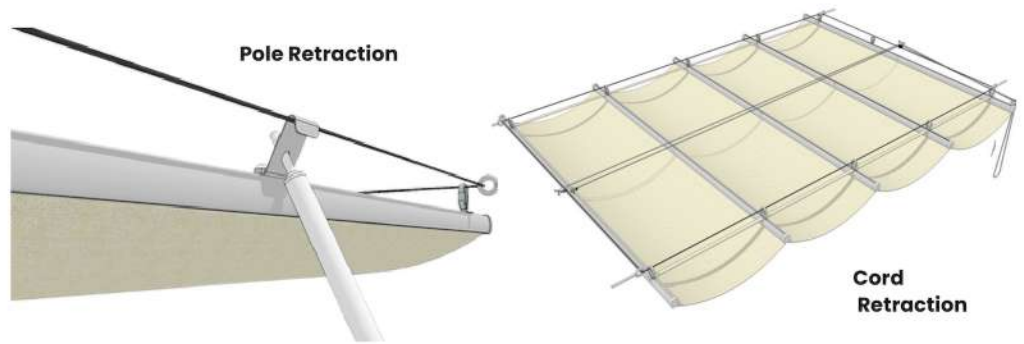

COMPONENTS

High-quality components and fabrics ensure durability. Marine-grade stainless steel fittings make them suitable for coastal areas. Standard spars come in silver pearl, with custom Dulux powder coating available.

CUSTOMIZATION

Width, length, colour, depth of billows: customizable for a precise fit

Drop: standard drop is 400-450mm, adjustable to a minimum of 280mm if needed

Billow: standard billow is 180mm, with options for a shallower or deeper look

FABRIC

Wave shades use commercial-grade, mildew, and mold-resistant fabrics that offer high UV and heat protection. They are fade-resistant, easy to clean, and come with a 5-year warranty.

- ShadeView 300: A high-performance, fire-retardant mesh with a 5% openness factor, available in 15 colours
- Serge Ferrari Soltis Lounge 96: Micro-perforated for natural light and airflow, offering tree-like shade. Features Précontraint® technology for durability and stability
- Serge Ferrari Soltis Proof W96: A waterproof solution that protects against UV and weather while allowing natural light transmission

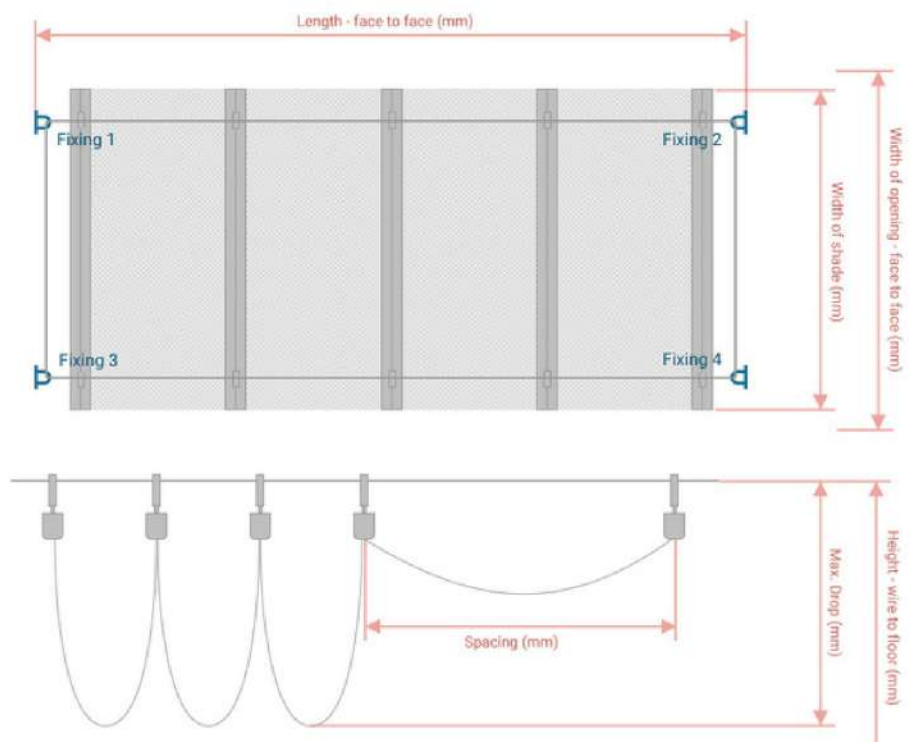

Shaderunner®

A fully custom made high quality shade system designed to cover large areas or more complicated sites that other retractable shade systems cannot manage.



KEY FEATURES

- Modern design
- Can be folded away when not in use
- Can span large areas - up to 7m (width) x 12m (extension)
- Mesh & waterproof fabrics available
- Effective protection from UV rays
- Manually operated (infinite cord & winch) or Somfy motorised

WARRANTY (Ts & Cs apply)

- Components - 5 years
- Fabrics - 5-10 years
- Somfy motors - 5 years
- Fabric stitching/welding - 10 years
- Workmanship - 5 years

PRO

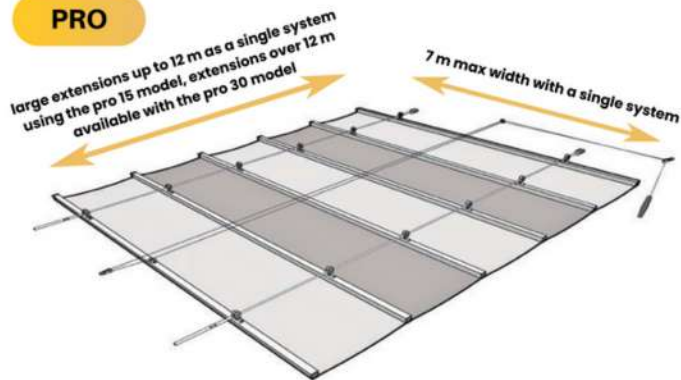

The Shaderunner® can be set up on a pre-existing or custom-made pergola, or between walls, fascias, and standalone posts. Manufactured using only the most durable 316 stainless steel fittings and marine grade Ronstan ball bearing pulleys, the Shaderunner® Retractable Sail provides years of hassle-free shading with minimal maintenance.



The latest PRO model comes with customizable fittings in all sections to offer more versatility. The fabric panels are fitted into the spars individually, which makes it possible to replace them if needed, and also to choose several different colours as an option.

Fabric drop: 250-500mm typical stowed fabric depth (custom designed to suit site conditions)

Running Wires: 2x Stainless Steel wires as standard (additional wires where required)

Operation: Manual operation with endless cord system
Motorised option with remote (conditions apply)

Motor type: Somfy RTS motor in powder coated slimline headbox

Sensors: Optional wind, sun or rain sensors

FABRICS

Vistaweave 95 is a high-quality woven mesh fabric ideal for outdoor applications such as blinds, awnings, and marine shades. Its distinctive weave blocks the sun's rays while providing an attractive textured look. It's mildew and saltwater resistant. Trusted in Australia and New Zealand for over four decades.

For waterproof shades, we use premium French-made fabrics—**Serge Ferrari Soltis W96** and **Soltis 502**. Both offer heat and weather protection, are dirt resistant, and easy to maintain. Serge Ferrari fabrics feature high dimensional stability due to their patented Precontraint® technology.



07 ALUMINIUM SHUTTERS

Muriwai - NZ Made

Elevate your outdoor space with our elegant **Muriwai Aluminium Outdoor Shutters**. Crafted in New Zealand from premium materials, the Muriwai Series seamlessly combines style and strength for both interior and exterior use.

Built to withstand high winds, these shutters underscore SunGuard's commitment to quality, utilizing top-notch aluminum and 316 stainless-steel components for longevity and resilience against the elements. With a **10-year finished product warranty**, Muriwai ensures both style and durability, requiring minimal maintenance and contributing to improved energy efficiency through its heat-deflecting properties.

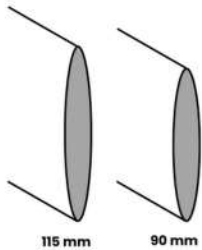

FULLY CUSTOMISED

Tailor Muriwai shutters to your needs with flexible fixing and blade options. Choose from **fixed in channels, off-the-wall built-out frames, hinged, sliding, or bi-folding configurations.**

Choose blade size between **90 mm x 12 mm** or **115 mm x 15 mm.**

Explore a palette of powder coating colours, including standard choices like **Pearl White, Silver Pearl, and Satin Black**. For a truly unique look, delve into custom colours from the **Dulux Duralloy** or **Interpon** ranges. The Muriwai range is adaptable to various openings' shapes, and is perfect for decks, patios, verandas, pergolas, balconies, and more, offering a sleek, modern design.



Muriwai requires very little maintenance, making it a cost-effective option over the long term. Aluminium shutters also improve energy efficiency. This is achieved through creating a barrier from the elements as aluminium is known for deflecting heat away from windows.

Flush Bolt 	Patio Bolt 	Whitco Key Handle Lock 	Keyable Lock (Throw Rods) 
---	--	--	---

Locking Options

Enhance security and versatility with Muriwai Series shutters, offering various locking choices.

For hinged panels, the recommended Whitco key handle lock ensures optimal security.

Bi-folding shutters require one locking system per pair of panels, securing them in both top and bottom tracks.

Sliding panels can be fitted with a patio bolt for each panel.

Choose the locking solution that suits your needs, providing peace of mind and adaptability to different applications.



Muriwai Aluminium Shutters - NZ Made			
Material		Aluminium - Grade 6060 tempered to T5	
Coating		Thermoset Powder Coating - 60 um	
Control Style		Clearview - side/rear with aluminium bar	
Blade Sizes		90mm x 12mm (fixed or operable louvre blades) 115mm x 15mm (operable louvre blades only)	
Stile Size		Width: 60mm	Thickness: 30mm
Midrail Size	90mm Blade	Width: 82mm	Thickness: 26mm
	115mm Blade	Width: 95mm	Thickness: 26mm
Minimum panel size (operable blades)	Hinged	Width: 250mm	Height: 250mm
	Bi-Fold		
	Fixed or Sliding		
Maximum panel size (operable blades)	Hinged	Width: 1000mm	Height: 2200mm or Height: 2700mm
	Bi-Fold	Width: 800mm	Height: 2700mm
	Fixed or Sliding	Width: 750mm	Height: 2700mm
Minimum panel size (fixed blades angled at 62°)	Fixed	Width: 130mm	Height: 120mm
Maximum panel size (fixed blades angled at 62°)	Fixed	Width: 1350mm	Height: 5000mm
Blade Depth Clearance	90mm Blade	70mm	
	115mm Blade	85mm	
Locking Requirements	Fixed Panels	No locks required	
	Hinged Panels	Recommended: 1 lock per every pair of hinged panels	
	Bi-Fold Panels	Required: 1 lock per every pair of panels	
	Sliding Panels	Recommended: 1 lock per every sliding panel	
Colours: Powdercoated	Standard	Pearl White, Silver Pearl, Satin Black	
	Custom	Dulux & Interpon Powder Coat Range	
Panel Weight		Approximately 13.8 kg per sq m	
Hinges		Hirline Hinge - 89mm fixed pin (stainless steel)	
Special Shapes		Rakes (fixed panels only) Gable end angled shutters	



08 INTERIOR SHUTTERS

Elevate your home's aesthetics with SunGuard's exquisite custom-made interior shutters. Designed with operating slats, our shutters not only allow you to filter sunlight but also provide unparalleled privacy and control over airflow, offering a perfect blend of elegance and functionality. Explore our diverse range of shutter types, including **fixed in U-channels**, **hinged**, **bi-folding** and **sliding panels**.

Discover the timeless charm of our **Timber Plantation Shutters** from the **Wanaka Collection**. Also known as Basswood shutters, these plantation shutters have captivated homeowners for decades. Our Wanaka timber indoor shutters offer classic elegance, lightweight durability, and practical sophistication.

Opt for the sleek, modern **PVC Plantation Shutters** from our **Omaha Collection**. Available in three blade sizes, these faux wood shutters offer limitless customization. Reinforced with aluminum, they are ideal for kitchens and bathrooms, excelling in moisture resistance and outperforming classic timber shutters.

	Wanaka Timber Shutters	Omaha PVC Shutters
Material	Basswood Species Tilia	Co-extruded Poly Vinyl Chloride
Coating	NC Lacquer - Top Coated	
Control Style	Centre with stainless steel staples Side/rear with aluminium bar Off set with stainless steel staples	
Blade Sizes	63mm x 11mm 89mm x 11mm 114mm x 11mm	
Stile Size	Width: 50.8mm	Thickness: 27mm
Midrail Size	Width: 82.55mm	Thickness: 19mm
Max height without Divider 1	1600mm	
Max height without Divider 2	2450mm	2200mm
Colours: Painted	99 - Arch White 105 - Snow 100 - Uniwhite 106 - Egg Shell 101 - White 108 - Swiss Coffee 102 - Silk White 110 - Creamy	113 - Ivory 118 - Sand 122 - Sahara 130 - Antique 134 - Mushroom
Colours: Stains	200 - Natural 215 - Java 201 - Honey 216 - Rose 205 - Oak 220 - Mahogany 230 - Black Walnut	N/A
Special Shapes (circles, angles)	Yes	Rakes only (some parts will be supplied in Basswood)
Warranty	10 year finished product warranty (Ts & Cs apply)	



PANEL SIZE LIMITATION

Panel Fixing	Blade Size	Min Width *Central	Min Width *Clearview	Max Width	Min Height	Max Height
Hinged Fixed	63mm	250mm	225mm	800mm (timber) / 650mm (PVC)	380mm	3000mm
	89mm	250mm	225mm	900mm (timber) / 800mm (PVC)	380mm	3000mm
	114mm	250mm	225mm	900mm (timber) / 800mm (PVC)	380mm	3000mm
Sliding	63mm	250mm	225mm	800mm (timber) / 650mm (PVC)	380mm	3000mm
	89mm	250mm	225mm	950mm (timber) / 800mm (PVC)	380mm	3000mm
	114mm	250mm	225mm	950mm (timber) / 850mm (PVC)	380mm	3000mm
Bi-folding w/track	63mm	250mm	225mm	600mm	380mm	2400mm
	89mm	250mm	225mm	650mm	380mm	2400mm
	114mm	250mm	225mm	700mm	380mm	2400mm

Extruded from premium-grade PVC, **Omaha plantation shutters** excel in high-temperature, high-humidity environments, ensuring longevity and resilience. Reinforced with aluminum inserts, Omaha shutters are sturdy and reliable.





Venetian blinds are the ultimate solution for enhancing privacy and controlling the sunlight in your room. At SunGuard, we offer a wide selection of Venetian blinds crafted from premium timber, versatile PVC, and sleek aluminium. Our blinds come in 25mm, 50mm, 60mm, and 63mm slats and a variety of colours for the other sizes to suit any décor. All our Venetian blinds come with a reassuring 5-year warranty – terms and conditions apply.

Marupa Timber

Available in 50mm slats (White, Black, Alabaster, Light Oak, Dark Oak) and 60mm slats (White).

Expertly crafted in New Zealand from high-quality Marupa (Simarouba amara) timber, these Venetian blinds are both durable and lightweight, perfect for any window size. The sustainably sourced Marupa timber exudes warmth and charm, and each slat is treated with advanced UV protective coatings to ensure long-lasting beauty and performance. Our timber blinds come with colour coordinated fascias (75mm), cords, and tapes, and include hold-down brackets for added stability. Customizable to fit windows as small as 250mm wide, these blinds offer elegance and functionality.

Woodefex PVC

Available in 50mm slats (White, Off-White, Canvas) and 63mm slats (White).

Woodefex Venetian blinds are a stylish and economical alternative to traditional timber blinds. Made in New Zealand from durable, UV-treated polyresin, these blinds are highly resistant to heat and humidity, making them ideal for kitchens, bathrooms, and laundries. The innovative material prevents bending or warping, ensuring easy operation and longevity. Available in three warm, neutral shades—white, off-white, and canvas—Woodefex PVC blinds provide a timeless, clean look. These blinds can be custom-made to fit windows as small as 250mm wide, offering both practicality and sophistication.

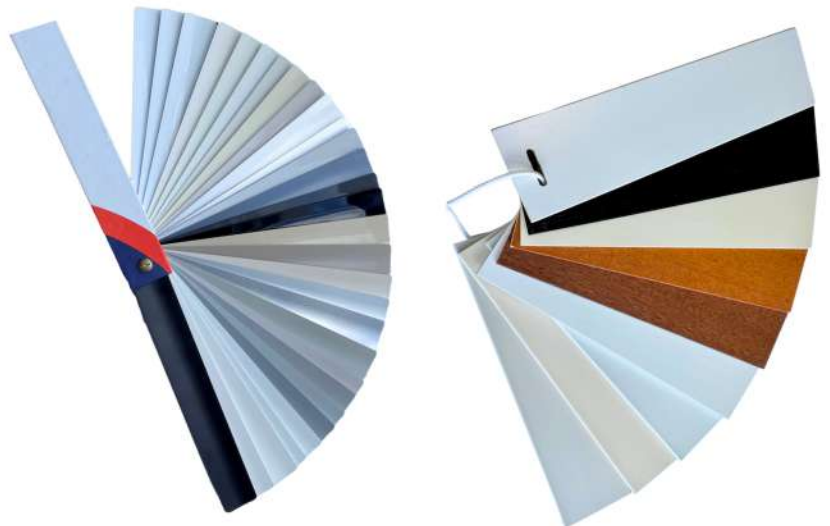

Aluminium

Available in 25mm slats (over 20 colours) and 50mm slats (Alabaster, Desert, Silver, White).

Our custom-made aluminium venetian blinds offer a sleek solution for those who wish to easily control light, visibility and privacy. With a 180 degree tilt, the slimline slats fit tightly when closed to create a blackout blind making them ideal for conference rooms and offices. Available in an extensive range of colours to suit any décor, our aluminium venetians are also extremely practical – easy-to-clean, heat- and moisture-resistant. Can be fitted inside or outside the window frame with left or right control options. Spring-loaded hold down devices are available.

10 ROLLER BLINDS

SunGuard roller blinds are custom-made to fit all your specifications. Choose from a variety of fabrics, colours, bottom rails, and control options to enhance any residential or commercial environment. We offer the following types of roller blinds:

Single Roller Blind

Standard roller blind with one fabric roll, mounted inside or outside the frame.

Linked Single/Double Roller Blind

Two or more blinds connected with a joiner, reducing gaps between adjacent fabrics. Operate multiple blinds with one chain/motor or separately.

Double (Dual or Day-Night) Roller Blind

Two roller blinds on a double bracket, each operated separately. Use semi-transparent fabric during the day and opaque fabric for privacy at night.

Dim-Out Single Roller Blind

Features side channels and a cassette for improved light block. Choose between square and round head box styles.

COMPONENTS

We use high-quality Australian-made Acmeda components with an efficient chain retention system and improved contouring. The Acmeda system secures the chain during operation, reducing drag and noise. Various tube sizes are available to accommodate different blind sizes and fabrics (35mm, 40mm, 45mm, 60mm, 100mm). We offer a variety of bottom rail designs and chains in different colours and lengths.

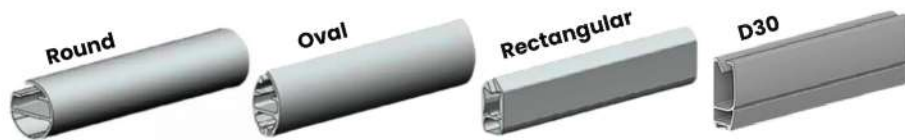

FABRICS

Our wide fabrics selection includes options from market leading brands such as Uniline, GAT, Shaw, Vertex, and Louvolite. These fabrics offer UV protection, are lead-free, tear and mildew resistant, with PVC-free options available. Enjoy peace of mind with warranties of up to 10 years.

Blackout Fabric

Blackout fabrics provide total light control, ensuring complete privacy and enhancing energy efficiency by regulating room temperature throughout the year. Ideal for bedrooms or media rooms, these fabrics effectively block sunlight to create a darkened environment conducive to rest and relaxation. Popular choices include **Dawn** and **Miami** (plain fabric), **Le Reve** and **Cascata** (textured).

Light Filtering Fabric

SunGuard's light filtering fabrics soften natural light while maintaining privacy without sacrificing daytime brightness. They reduce glare and protect against harmful UV rays, perfect for creating comfortable living spaces with a natural, subdued light. Popular options in this category include **Linesque** and **Mantra**.

Sunscreen Fabric

SunGuard offers sunscreen fabrics in various opacities from 2% to 10% openness, preserving natural light and views while providing daytime privacy and UV protection. These fabrics are ideal for offices and study rooms, ensuring a comfortable, well-lit environment essential for productivity. Popular choices include **Uniview 10%** and **Vertex Vision 5%**.

ROLL OPTIONS

Front Roll and Back Roll:

Back roll fabric runs closer to the window, minimizing light gaps at the sides.

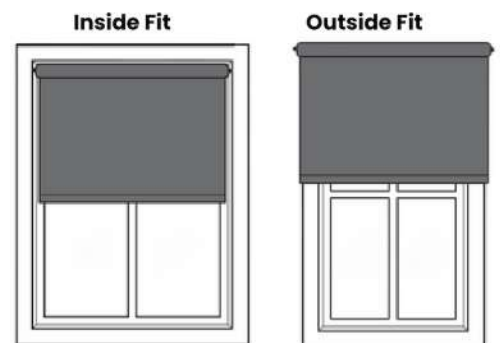
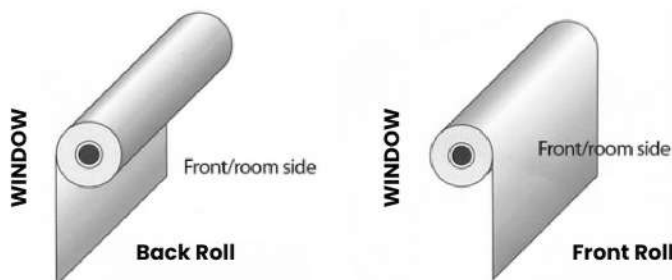

INSTALLATION OPTIONS

Inside Fit: Looks tidy inside the window frame with small light gaps at the sides.

Outside Fit: No light gaps at the sides, with brackets sitting outside the window.



CF90 Square

CF90 Round

CF 90 DIM-OUT

For a more effective blackout solution that removes light gaps at the sides, consider our high-quality **Acmeda dim-OUT system**. This system covers the top and side light gaps present in standard roller shades, enhancing your home's energy efficiency. Please note, however, that this system does not block out 100% of light. With clean lines and harmonious aesthetics, it is available in round or square finishes. Choose from four stylish colors: pure white, black, sandstone, and anodized.

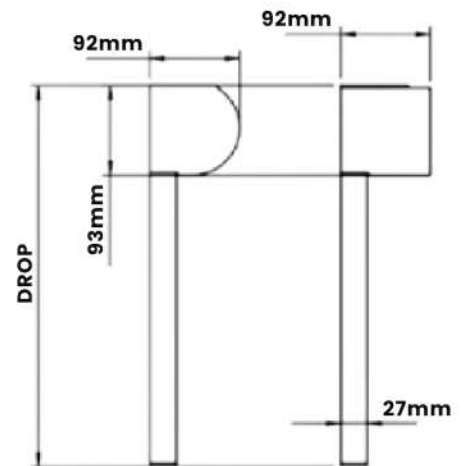
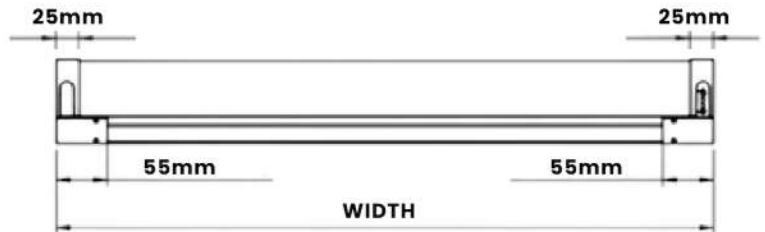

OPERATION

Roller blinds can be operated manually with a chain or automatically for added convenience and functionality.

With **the chain-operated option**, you can customize the length, colour, material, and control side (left or right) of the chain. We offer a variety of chains, including plastic chains in white, black, grey, and birch white, metal and stainless steel chains, which are ideal for coastal and humid areas.

Motorized roller blinds, operated by a tubular motor, offer a modern alternative to traditional chain controls and can be controlled with a remote, wall switch, or phone app, providing flexibility and ease of use.

MOTOR TYPES

- **Hard Wired Motors:** Connect to mains power, wired by an electrician, no charging required.
- **Rechargeable (Wire-Free) Motors:** Equipped with a charger similar to a cell phone charger, they require recharging approximately every 12 months, depending on the model and usage. These motors are easy to install without an electrician and can be charged with a wall charger or a solar panel for continuous power.

CONTROL OPTIONS

Motorized roller blinds can be operated using wired or wire-free wall switches or handheld remote controls, allowing control of up to 16 individual or grouped blinds simultaneously. With a Wi-Fi hub, you can control your roller blinds through a phone app or integrate them into your smart home system, including Alexa, Google Home, and Apple Home. Group shades by room or scene, establish custom schedules, and set timers for convenient and efficient shade control.

AUTOMATION BRANDS

- **ACMEDA:** A US-based company with divisions in Australia and Europe, offering quality motors, controllers, sensors, and smart home integration systems for luxurious and effortless experience.
- **SOMFY:** A leading manufacturer of smart shade solutions with over 50 years of design and innovation history. Based in France, Somfy is known for its European style and premium quality.
- **ALPHA:** Reliable and affordable, Alpha Motors offer intuitive motorization solutions at a competitive price. Known for their versatile remote controls and best warranty policy on the market. Based in Australia and China.
- **DOOYA:** A leading manufacturer of shade automation solutions and smart home systems. Their product range includes tubular motors, venetian blind drives, curtain motors, control systems, and smart control interfaces. Dooya is known for cost-effective tubular motors with safe, simple installation and set up.

WARRANTY (Ts & Cs apply)

- Components: 5 years
- Workmanship: 5 years
- Fabric: 5 years
- Somfy Motors: 5 years
- Alpha/Acmeda Motors: 7 years



Acmeda Automation



Sunscreen Blinds

11 HONEYCOMB BLINDS



Cosiflor® (Blackout)



Double Cell (Light Filtering)

Cosiflor®

Discover **the Cosiflor® Collection**, where sophistication meets functionality. This honeycomb fabric, featuring a **20mm cell size**, boasts a twin-wall design that creates insulating air pockets, ensuring year-round comfort in your home.

Designed and manufactured in Europe, Cosiflor® is celebrated for its use of high-quality materials and sleek, slimline blind systems. Made with asymmetrical honeycomb shapes, Cosiflor® honeycomb blinds maintain impeccable aesthetics and prevent front pleat sagging, ensuring a consistently smooth and stylish look.

FOR EVERY WINDOW TYPE

Cosiflor® honeycomb blind systems cater to a variety of window types:

- **Standard Windows:** Available in tensioned or free-hanging styles, operated by handle, chain, or cord, with options for remote control
- **Irregularly Shaped Windows:** Offered in fixed or operable configurations, controlled manually or with a cord
- **Conservatory and Ceiling Windows:** Manual or automated options, operated via rod, remote control, or wall switch
- **Velux Skylights:** Easily adjustable with a hinged control stick

FABRIC

Available in shades of grey, beige, and white, Cosiflor® honeycomb blinds cater to diverse interior aesthetics.

The blackout fabrics feature a special aluminum foil lining that enhances insulation properties, making them ideal for maintaining room temperature and privacy. **The light filtering fabrics** have a white backing that diffuses incoming light, creating a soft, ambient glow while maintaining your privacy.

AUTOMATION

Experience the convenience of automated Cosiflor® honeycomb blinds, featuring **Somfy** or **Galaxy motors**, ensuring seamless operation and enhanced comfort at your fingertips.

DAY-NIGHT OPTION

Cosiflor® honeycomb blinds feature a 'Day-Night' option, incorporating two fabrics in one shade for adaptable sun protection. Adjust sunlight levels by choosing denser fabric for maximum shading during quiet times such as daytime naps, and translucent fabric for diffused daylight preferred during work or leisure.

Core Collection

If you're looking for honeycomb blinds that offer affordability without compromising on quality, our **Core Collection** is the perfect choice. Crafted in Taiwan and backed by a 2-year warranty, these blinds are available in two cell sizes: **38 mm (single/double cell)** and **25 mm (single cell)**.

FABRIC

Choose from a wide selection of blackout and light filtering fabrics, featuring plain, textured, matte, glossy, linen textures, and designer prints. Our single cell blackout honeycomb blinds feature an aluminum foil lining for enhanced insulation.

OPERATION

Operate your blinds with ease:

- **Standard cord**, similar to venetian blinds
- **Looped cord (clutch operated)**, ideal for children's bedrooms
- **Cordless**, for a sleek and child-safe option
- **Top-Down/Bottom-Up**
- **Day-Night** blinds, combining blackout and light filtering fabrics in one



Day-Night (Light Filtering & Blackout)



Cosiflor® (Light Filtering)



Core Collection (Blackout)

Luxaflex® Duette Shades

SunGuard is proud to be a retailer of Luxaflex®, offering their innovative and high-quality products. Duette® Shades are the premier honeycomb shades system, designed for durability, elegance, and versatility. Made of pleated, reinforced fabrics that form compartments of trapped air, these shades provide ultimate functionality and energy efficiency. The anti-static, dust-resistant fabric makes cleaning easy and promotes better air quality.

SIZES

Available in 10mm and 20mm cell sizes.

CONFIGURATION

- Bottom Up: Traditional operation, raising the bottom rail to open and lowering to close
- Top Down: Covers the lower part of the window while allowing light and view from the top of the window
- Top Down/Bottom Up: Versatile operation from both the top and bottom for optimal light and privacy
- Duo-Lite: Combines two fabric panels for day and night control
- LightLock: Ultimate room darkening with patented side channels

DUETTE® ARCHITELLA® SHADES

The ultimate in honeycomb cellular design, Duette® Architella® Shades feature three internal air pockets for superior insulation and energy efficiency. They can significantly reduce heating costs and improve sound control by reducing noise transmission. Available in an exclusive range of blackout and translucent fabrics, these shades are highly regarded by interior designers.



FABRIC OPTIONS

- Blackout: Complete light blockage, ideal for media rooms and bedrooms
- Translucent: Allows light while protecting furnishings from UV damage
- Sheer: Softens and colours the view outside while blocking minimal light

COMPONENTS COLOURS

Gardenia White, Aspen White, White Tiara, Stone, Pearl Grey, Twilight, Black.

SPECIALTY SHAPES AND DURABILITY

Duette® Shades can be fitted to various window shapes, including semi-circles and bays, and mounted inside or outside of the frames. Made from hard-wearing spun-bonded polyester, they are highly durable and perfect for any setting.

OPERATION

- EasyRise: Continuous loop cord design, ideal for large windows
- LiteRise: Cordless system for added child and pet safety
- PowerView® Automation: Wireless control via remote, app, or voice, with flexible scheduling for energy efficiency
- UltraGlide®: Retractable wand mechanism for child-safe operation
- SkyLift with PowerView® Automation: Perfect for large, high windows, combining energy efficiency with smart technology



12 PLEATED BLINDS

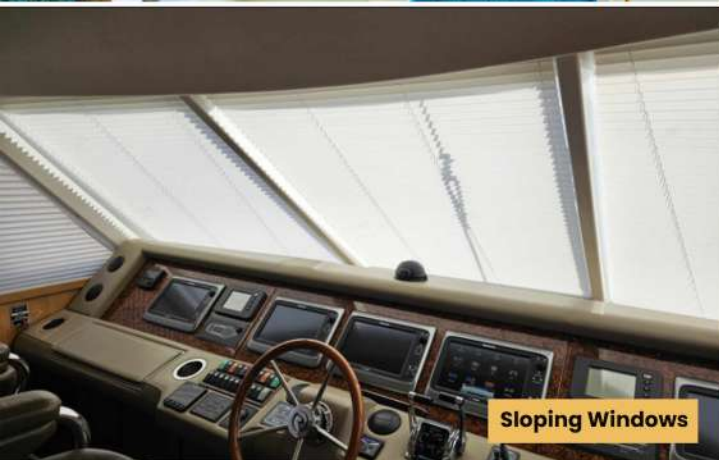

At SunGuard, we specialize in custom-made **20mm pleated blinds** that fit seamlessly into any space, be it your home, workplace, or boat. Featuring a supportive ladder design to prevent slipping, our pre-tensioned blinds offer precise coverage, making them perfect for skylights, angled windows, roof windows, and conservatories. Engineered with guide wires for stability, they ensure a secure fit without rattling against the glass.

PLEATED BLIND SYSTEMS FOR VARIOUS WINDOW TYPES

- **Standard Windows:** Tensioned or free-hanging, operated by hand, with a rod, chain, or cord. Remote control options available
- **Irregularly Shaped Windows:** Fixed or retractable, controlled by hand or cord
- **Conservatory and Ceiling Windows:** Manual or automated, operated by rod, remote, or wall switch
- **Skylights:** Operated by a hinged control stick for easy adjustment

DAY-NIGHT OPTION

Pleated blinds offer a 'Day-Night' option, combining two fabrics in one shade product for flexible sun protection. This feature allows you to adjust sunlight levels as needed: use denser fabric for maximum shading during quiet times like daytime naps for children, and choose translucent fabric for diffused daylight preferred during work or leisure activities.

GREAT CHOICE OF COLOURS AND PATTERNS

Our high-quality pleated blinds come in a range of luxurious textures and finishes, including bright colours and bold patterns. We offer vibrant shades like bright green, blue, pink, orange, and yellow, as well as stripes and various patterns to match your decor. Components are available in colours like White, Silver, Grey, Charcoal, Dark Chocolate, and Bronze, for a seamless look.

COMPACT WINDOW TREATMENT SOLUTION

Pleated blinds offer a space-saving design, ideal for areas where every centimeter counts. They occupy minimal space when raised, stacking neatly at the top of the window for an unobstructed view and maximum natural light. Perfect for aluminum joinery, classic timber frames, and modern uPVC windows, they are also great for boats and yachts. Their lightweight yet durable construction suits marine environments, combining functionality with style while maintaining light control and privacy.

EUROPEAN QUALITY

Our fabrics, sourced from German manufacturers J&M and Blocker-Cosiflor®, include metallic prints, solids, patterns, textured jacquards, and pearl reflecting coatings. All fabrics are Oeko-Tex certified, ensuring they are safe, dust-resistant, and durable.

CHILD AND PET SAFETY

Safety is paramount – our blinds offer cordless options or child-safe mechanisms. Corded blinds include the **Child Safety Cord Winder**, which activates automatically when the cord is extended up to 60mm and under a pressure of 6kg.

EASY MAINTENANCE

Our pleated blinds are easy to clean with mild soapy water, making them ideal for busy households.

Operation Options



Manual (chain or cord)

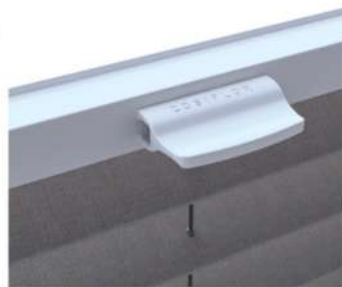

Manual (handle)



Manual (cardan stick)



Automated

VERTICAL BLINDS 13

Ideal for large windows and doors such as ranch sliders and bi-folds, and perfect for areas with minimal clearance. Great for commercial applications, our elegant and versatile vertical blinds provide effective light and heat control.

FABRIC

Our vertical blinds are available in **89mm, 100mm, and 127mm** slat widths to accommodate all style and design requirements. We offer an extensive selection of quality **blackout** and **light-filtering** fabrics. The PVC-free acrylic coating has anti-fade, easy clean, and antifungal properties. Greenguard Gold Certification ensures low chemical emissions, significantly improving air quality.

SLIM HEADRAIL

Featuring a 28mm slim headrail, our blinds fit seamlessly into lower window frames, providing a sleek and unobtrusive appearance.

DURABLE CARRIERS

Polycarbonate carriers offer superior strength and security, ensuring that your blinds are both sturdy and reliable.

CONTROL OPTIONS

For ease of operation and child safety, we offer wand control, as well as standard chain and cord control. Stainless steel control chain is also available for a premium touch.

TRACK COLORS

Our track colors include White, Birch White and Black, allowing you to match or complement your interior decor.

BOTTOM WEIGHTS

Select from chained or chainless bottom weights, which can be welded or sewn in, to achieve the desired look and functionality.

CUSTOM SOLUTIONS

We offer custom-designed sloping blinds to fit non-standard windows, ensuring that every space can benefit from our high-quality blinds.

AUTOMATION

For added convenience, our blinds can be automated with the Somfy automation package (Luxaflex® EOS® Helix series only).

WARRANTY

Our products are backed by a 5-year warranty for the standard range and a 3-year warranty for the Luxaflex® range, providing peace of mind and assurance of quality.



Control and Stacking Options

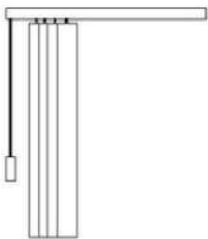

1. Stack Left
Controls Left

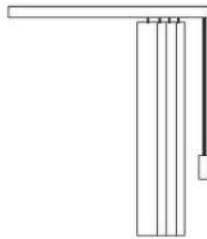

2. Stack Right
Controls Right

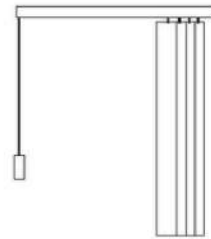

3. Stack Right
Controls Left

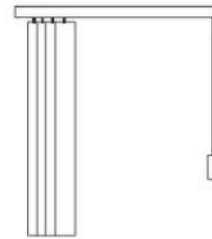

4. Stack Left
Controls Right

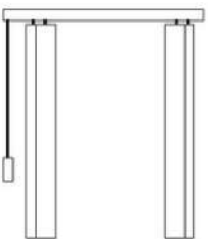

5. Stack Both
Controls Left

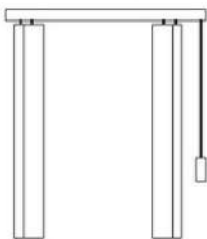

6. Stack Both
Controls Right

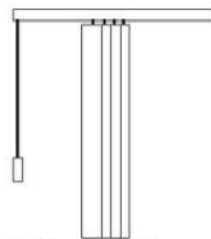

7. Stack Middle
Controls Left

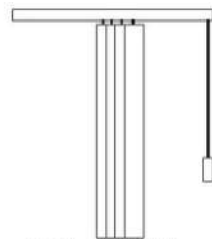

8. Stack Middle
Controls Right

+64 27 217 9560

WWW.SUNGUARD.NZ

SALES@SUNGUARD.NZ

G/11 PIERMARK DRIVE,
ROSEDALE, AUCKLAND 0632

Sun | Guard

Your Sunshade Experts



Interest Free Finance

We have partnered with Gem Visa & QCard to bring interest free deals so you can get your sunshade products today.

(T's & C's apply, only available to eligible borrowers)